



CASELINER[®]
MOTORSPORT PIT EQUIPMENT



CASELINER®

We are a direct manufacturer and offer a wide portfolio of motorsport products known as PIT EQUIPMENT. The foundations of our company were laid in the mid-1990s and our experience is based on successful racing on European tracks. Our international team is dedicated to projects across all motorsport categories around the world. Our direct production processes use the latest technologies, such as multi-axis CNC machining, semi-automated certified welding, and production and quality control systems. We strictly follow the technical regulations in compliance with the FIA, ACO, IMSA rules for all our products. We are able to supply standard and custom equipment according to your requirements to meet your needs.



INNOVATION

We always look to the future and our goal is always to be one step ahead. We feel what you need and know what's new at the same time, so we work with more power and efficiency.



PERFORMANCE

We produce PIT EQUIPMENT at reasonable prices, with higher than known general standards and all aspects of fast delivery terms.



DESIGN

The harmony of pure design and function are essential elements of our products, which we strive to offer you in our wide portfolio. Here you will find everything you need for your activities.



USER INTERFACE

All our products are designed and manufactured for everyday use. Whatever the weather, the products are designed for everyday use.



FUNCTION

We know that function is most important. We work during your daily routine, on important test days, but most importantly, during a race where every hundredth of a second counts towards the best result.



CORPORATE SOCIAL RESPONSIBILITY

For us responsible business means to offer our customers the highest quality goods and at the same time to treat our surroundings well so that our activities are sustainable in the long term.

Photos: ©CASELINER ©Julien Delfosse ©Paul Foster ©Xynamic

The CASELINER Catalogue was written by the CASELINER Marketing Department. All rights reserved.

The CASELINER is registered with trademark OHIM, N°009121161.

The CASELINER is registered with trademark USA, Reg. N. 4.676.996 / Serial N. 79-142.034

The MAGSEAM is registered with trademark, EUIPO, N. 0180065394

The visual material may not correspond to the text description, these are illustrative pictures or photos of the products with accessories. Always request an exact specification.

FLIGHT CASES

ROCK AND ROLL LIVES ON



Our goal is to produce high quality transport cases with long lifetime, high torsional rigidity and modern design. All the boxes are made to measurement according to your request at professional level, as it is our standard. We can recommend all our flight cases for many purposes in catering, flight cases for driver equipment (helmets, dryers, radios), tools and equipment (weights, geometry, lasers, turntable) etc.

We can prepare the cost estimate on your demand for tailored boxes any specifications according to your request.



UNICASE PRO

#0010111000-1-2

This flight case has a full opened upper lid, the space inside can be divided by shift partitions or empty. Please choice your accessories - 100mm, inner modular panels, rubber feet or color design.

- type 60 / 600 x 600 x 600 mm / 23,62" x 23,62" x 23,62"
- type 90 / 900 x 600 x 600 mm / 35,43" x 23,62" x 23,62"
- type 120 / 1200 x 600 x 600 mm / 47,24" x 23,62" x 23,62"
- 9 mm / 0,35" standard_black plywood / colors on demand



TOOLBOX

#0010211002

Is a special transport flight case for tools and spare parts, including one upper modular drawer.

- 600 x 600 x 950 mm / 23,62" x 23,62" x 37,40"
- 9 mm / 0,35" standard black plywood / colors on demand



TOOLBOX DOUBLE

#0010211004

Is a special transport flight case for tools and spare parts, consists of two cases and working plate with measurements 2000 x 550 mm / 78,74" x 21,65", creating a working bench

- work plate 2000 x 550 mm / 78,74" x 21,65"
- as the same as the specifications TOOLBOX CLASSIC



TOOLBOX MINI

#0010211001

Is a special transport flight case for personal tool equipment. Recommended for rally mechanics.

- 500 x 370 x 200mm / 19,68" x 14,56" x 7,87"
- 9 mm / 0,35" standard black plywood / colors on demand
- holder for tools

FLIGHT CASES

ROCK AND ROLL LIVES ON



TOOLBOX BIGGER

#0010211005

Is a special transport flight case for tools and spare parts, this flight case is including 6 PVC boxes and 4 x drawers - 2 x upper are modular.

- 1200 x 600 x 1080 mm / 47,24" x 23,62" x 42,51"
- 9 mm / 0,35" standard black plywood / colors on demand
- 4 drawers (1x modular)
- 6 PVC boxes



TOOLBOX MAXI

#0010211010

Is a special bigger transport flight case for tools and spare parts, this flight case is including 8 + 4 PVC boxes.

- 1800 x 850 x 1010 mm / 70,86" x 33,46" x 43,30"
- 9 mm / 0,35" standart black plywood / colors on demand
- 8x PVC boxes



PC-TELEMETRY CASE 2

#0010211006

PC / TELEMETRY is suitable for processing telemetry, mobile offices etc. The case has locking lids, in which LCD or LCD / TV monitors are placed. (TV/LED monitors on demand)

- 1200 x 605 x 890 mm / 47,24" x 23,81" x 35,03"
- 9 mm / 0,35" standard black plywood / colors on demand
- 3x inner drawers for notebooks, printers, etc...
- 2x drawers



PC-TELEMETRY CASE 3

#0010211011

PC / TELEMETRY is suitable for processing telemetry, mobile offices etc. The case has locking lids, in which LCD or LCD / TV monitors are placed. (TV/LED monitors on demand)

- 1775 x 605 x 890 mm / 69,88" x 23,81" x 35,03"
- 9 mm / 0,35" standard black plywood / colors on demand
- 4x inner drawers for notebooks, printers, etc...
- 2x drawers



PC-TELEMETRY CASE 6

#0010211012

The latest edition of our PC TELEMETRY CASE with 6 TV LCD monitors. Ergonomic placement of TV monitors, plenty of storage areas and space for PC, notebooks, and printers. Sliding drawers and workbenches. HDMI multi connect, USB plugs and all other cablings. (TV/LED monitors on demand)

- 1810 x 785 x 920 mm / 71,65" x 30,90" x 36,22"
- 9 mm / 0,35" standard black plywood / colors on demand
- 3x inner drawers for notebooks, printers, etc...
- 5x drawers

*standatrd color is black, other colors on request



The visual material may not correspond to the text description, these are illustrative pictures or photos of the products with accessories. Always request an exact specification.

TROLLEYS & WHEEL BATHS

FOR ULTIMATE CARE...



TYRE TROLLEY PRO160

#0020321002

TYRE TROLLEYS for transport and storage of tires made of stainless steel. The finish is chemically polished, welding is done in top quality. Trolleys are dismantlable with an option of two different lengths 1600 or 1400mm. As an accessory you can choose a tow bar and a pin attachment.

Optional accessories (not included in price):

- 0020332001 / TOWING SET - S-UNI
- 0020332002 / TOWING ATTACH. - S-UNI
- 0020332003 / TOWING ADAPTER ISO50

BOTTLE TROLLEY

DOUBLE

#0020521002

For two pressure bottles 15 or 18L, (3,96 to 4,75 gal) diam. 186 to 204mm. Safety valve bar and holder for gun or air lance are optional.



BOTTLE TROLLEY DINO

#0020521004

For pressure bottles diam. 186 to 204mm with holder for DINO PAOLI air regulator. Safety valve bar and holder for gun or air lance are optional.

BOTTLE TROLLEY DOUBLE DINO

#0020521008

For two pressure bottles 15 or 18L, (3,96 to 4,75 gal) diam. 186 to 204mm with holder for two DINO PAOLI air regulators. Safety valve bar and holder for gun or air lance are optional.



BOTTLE TROLLEY SINGLE

#0020521001

For pressure bottles 15 or 18L, (3,96 to 4,75 gal) diam. 186 to 204mm. Safety valve bar and holder for gun or air lance are optional.



TYRE TROLLEY HEATING

#0020121003

Folding trolley made from stainless steel designed to heat the tyres with warm up quilts. Folding frame with quick release.



HOLDER - GUN

#0020521053

HOLDER - AIR LANCE

#0020521054

SINGLE PROTECTION VALVE

#0020521051

DOUBLE PROTECTION VALVE

#0020521052

TROLLEYS & WHEEL BATHS

FOR ULTIMATE CARE...



TYRE TROLLEY FORMULA

#0020121001

High quality trolley made from stainless steel for transport of tyres. Folding plate.



AIR BOTTLE 15/18L

#0020731115 + 0020731118

We offer cylinders with a volume of 15 or 18L. We also offer large 300 barrel bottles with a volume of 40 or 50L. Textile packaging on request including printing.



WHEEL BATH SINGLE

#0030121001

Essential product for cleaning and preparation of the tyres. It is fitted with two pairs of bearing rollers for easy rotation of the wheel during the cleaning. Material stainless steel, removable legs, one adjustable leg, four adjustable rotary roller.



WHEEL BATH DOUBLE

#0030121002

Essential product for cleaning and preparation of the tyres. It is fitted with two pairs of bearing rollers for easy rotation of the wheel during the cleaning. Material stainless steel, removable legs, one adjustable leg, four adjustable rotary roller.

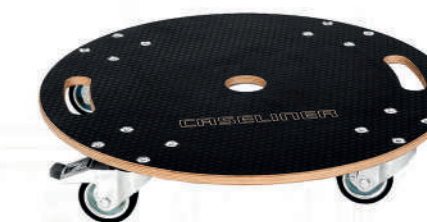

TYRE BOARD-DOLLY

#0020411001

Special plate for stocking wheels and tyres.

- accessories tyre retention bar



MECHANICS CHAIR

#0020721000

Stainless steel mechanic's chair with 4 wheels and tools area.

TYRE HEATER RACKS

SPA FOR YOUR TIRES...

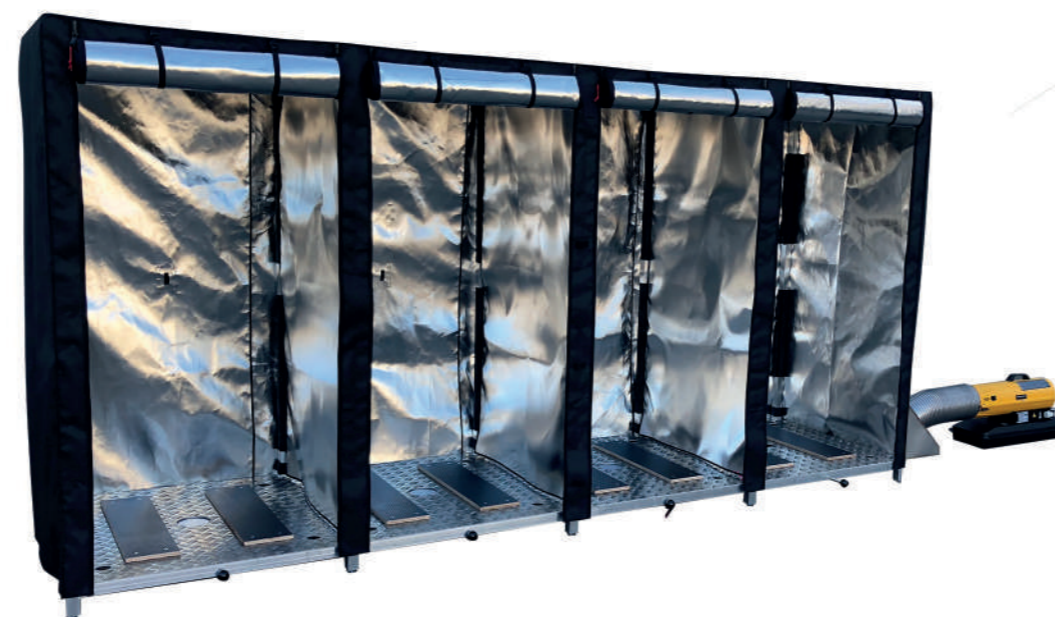
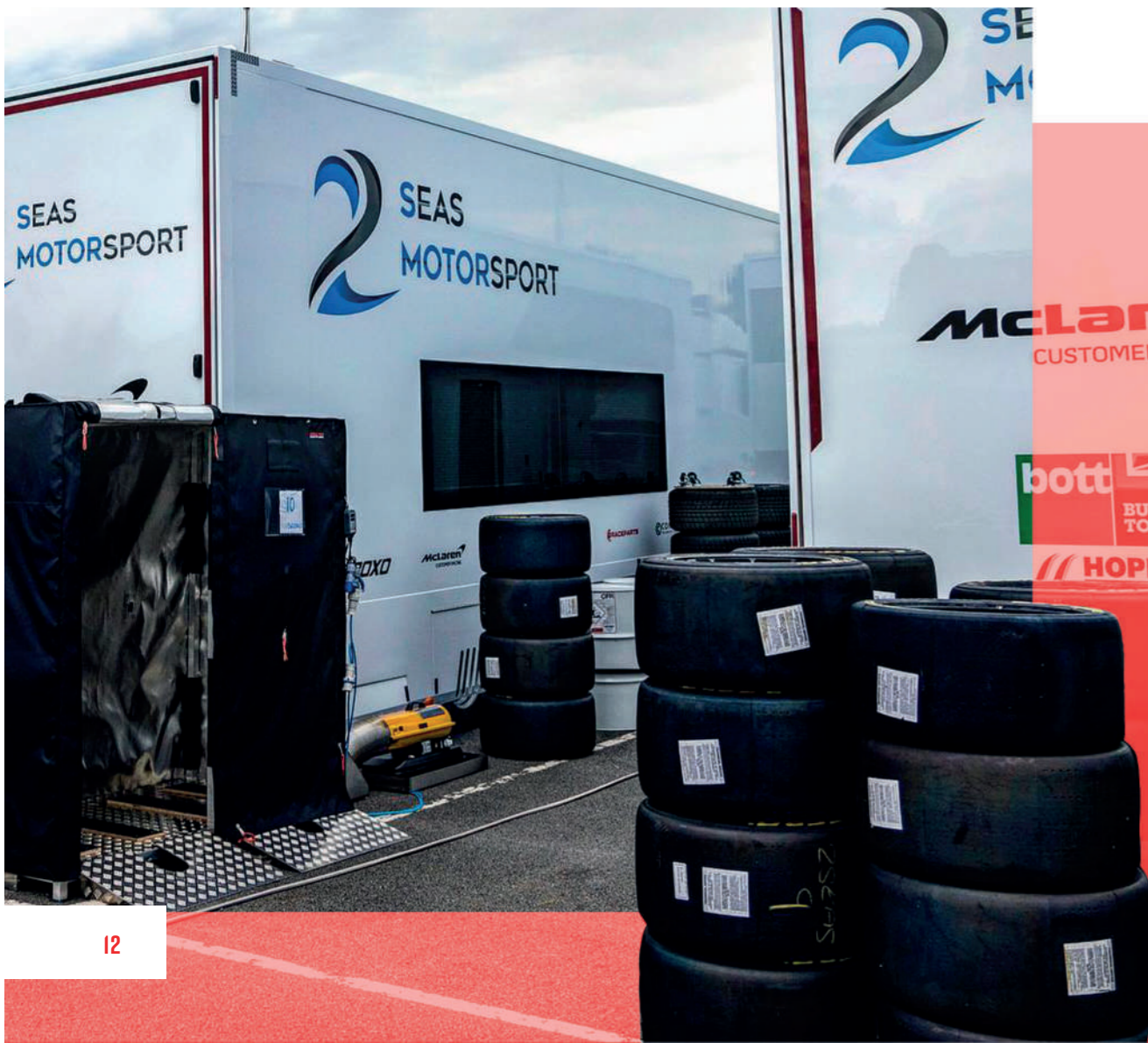

TYRE HEATER RACK ENDU4

#0040121044

Special warm box designed for heating of tyres during the endurance races. Easy to assemble by aluminium construction with a textile covering AIRTEX and internal thermal material that keeps heat well. Four chambers, independently heated with a mechanical controlled temperature level. Four zippered sections for access to the tyres with a small inspect window to control and measure the actual temperature. Transport flight case is optional, for all parts, incl. heater.

- full demountable
- 3800mm width [149,60"]

HEATER B70CED

#0040121002

Extremely easy portable heater. Transport flight case for the Heater is optional.

- 230 / 50 / HZ
- 20kw power
- fuel ELTO / Diesel
- consumption 1,7kg / h



TYRE HEATER RACK ENDU2

#0040121022

Special warm box designed for heating of tyres during the endurance races. Easy to assemble by aluminium construction with a textile covering AIRTEX and internal thermal material that keeps heat well. Four chambers, independently heated with a mechanical controlled temperature level. Two zippered sections for access to the tyres with a small inspect window to control and measure the actual temperature. Transport flight case is optional, for all parts, incl. heater.

- full demountable
- 1920mm width [75,59"]
- 1900mm high [75,59"]
- 980mm depth [38,58"]



TYRE HEATER RACK

#0040121001

Designed for the endurance racing, tyre heater rack can pre-heat up to three sets of tyres. The frame is constructed in two sections from stainless steel. The warm is kept within the rack by a strong PVC silver/thermo AIRTEX awning, which can be unzipped in two individual sections. Transport flight case is optional.

- full demountable
- 2000mm width [78,74"]
- 2000mm high [78,74"]
- 1000mm depth [39,37"]

Optional accessories (not included in price):

FLIGHT CASE THR
#0040111002

FLIGHT CASE HEATER
#0040111001

FLIGHT CASE THR E2
#0040111022

TEMPERATURE DATALOGGER CON2-C
#0040121042

FLIGHT CASE THR E4
#0040111044

TEMPERATURE DATALOGGER CON4-C
#0040121044

START-STOP SWITCH
#0040121050

TP1000-M TEMPERATURE SENSOR
#0040121011

HEATER B70CED
#0040121002

USB-C COM
#0040121045

TYRE HEATER RACKS

SPA FOR YOUR TIRES...



14

FLIGHT CASE HEATER B70

#0040111001

Special flight case for HEATER B70. Other models on request.



START-STOP SWITCH

#0040121050

START-STOP SWITCH for controlling the HEATER. This allows you to control the temperature inside the MASTER HEATER RACK more accurately. The inlet temperature sensor maintains a stable internal temperature.



TYRES WARMER LEO

#0040121301

CAPIT has always produced tyrewarmers for cars of excellent technical and aesthetic quality, able to immediately make the tires performing and close to the best condition of use, thanks in particular to the uniformity of temperature that tyre warmers for cars are able to guarantee on the entire surface of the tyre.

- high-precision digital temperature management
- temperature between 0-120 °C/32-248 °F
- other variants and dimensions on request



TYRES PRESSURE CONTROLLER

#0040121401

Optimize tyre pressure in just one step. Reduces time for pressure preparation. Remote control via Bluetooth app. Battery operation. Pressure deviation of maximum 0.0025 bar.

- durable transport box
- App from the App Store or Google Play



TYRES WARMER SUPREMA

#0040121311

CAPIT tyrewarmers are the excellence of the tyre warmers product. They are equipped with a ultra-compact and impact-resistant control box integrated in the tyre warmer.

15

GARAGE

I ALWAYS WANT IT GARAGE LIKE THIS...

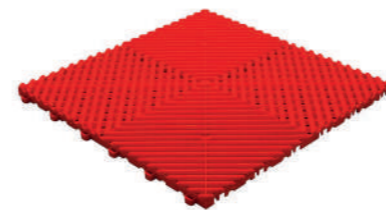

RACEFLOOR

#0090141002

RACEFLOOR, the flooring for all your racing needs. The tiles are easy to install due to an ingenious snap-in system. They have been developed to be used on any flat base, indoor or outdoor use. UV-stable.

- size 40 x 40 x 1,8 cm / 15,74" x 15,74" x 0,7"
- weight 552 g / 1,21 lb
- compressive strength 5120 psi
- 14 colors

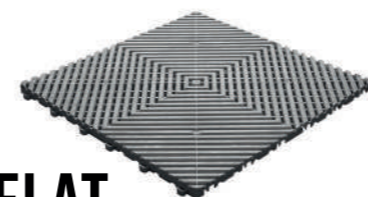

RACEFLOOR FLAT

#0090141022

RACEFLOOR, the flooring for all your racing needs. The tiles are easy to install due to an ingenious snap-in system. They have been developed to be used on any flat base, indoor or outdoor use. UV-stable.

- size 40 x 40 x 1,8 cm / 15,74" x 15,74" x 0,7"
- weight 552 g / 1,21 lb
- compressive strength 5120 psi
- 14 colors

WALLING SET 210-5

#0100231001

Is an aluminum profile system, suitable for creating screens inside of the boxes, stalls and presentation modules. Easy connection using locks, variability and time-saving assembly - these are the main advantages of this system.

- one set / 2100x990mm / 82,67" x 38,97"
- white panel, 4mm / 0,15"



WALLING CASE 50/210

#0100221005

We offer also special WALLING FLIGHT CASE for 50 sets of frames and panels 2100x990mm. (82,67" x 38,97")

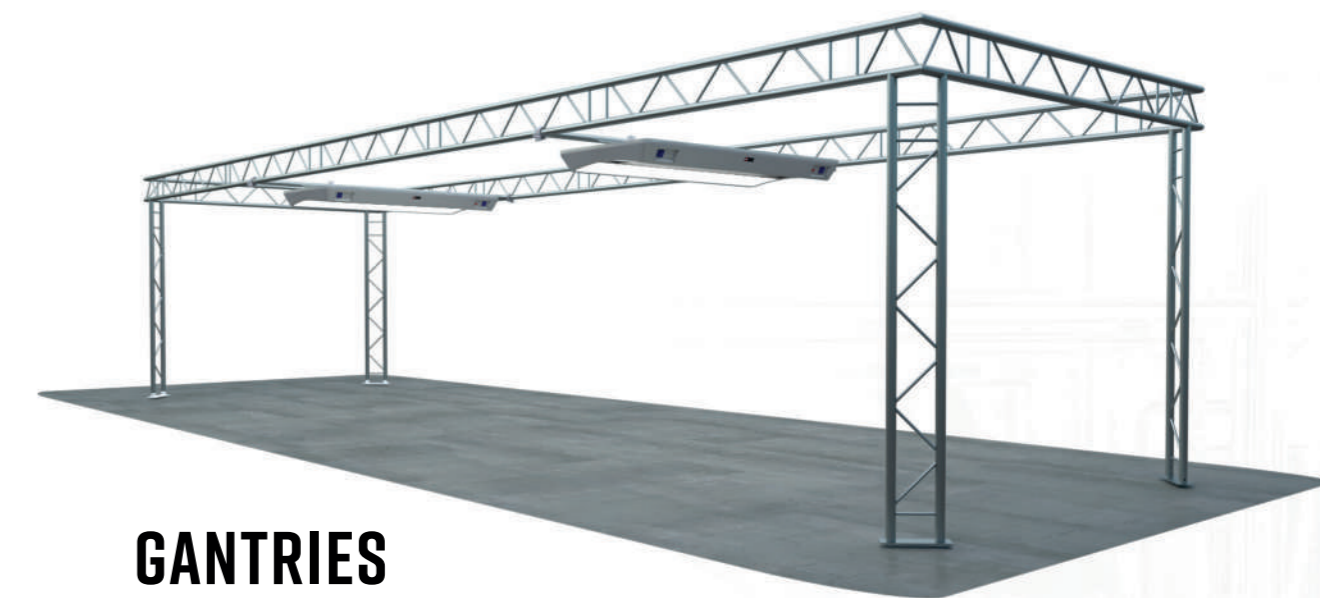

GANTRIES

System is available in three versions BI-SYSTEM, TRI-SYSTEM and QUATTRO-SYSTEM, 50mm diameter of tubes. Couplings, CELLS, are the auxiliary parts used for hanging of any equipment.



POWERHOOD S200C

#0120111001

Special POWERHOOD S200 is made for lighting in the race boxes, lighting over the race car, motorbike or at the workshops. Light construction, high luminosity together with an essential use and elegance

- 2000x1000x140mm / 78,74" x 39,37" x 5,51"
- Luminosity 20000 lm
- regulation of luminosity 35%, 65% or 100%
- 88-132V or 176-264V selected by switch
- 4x corner sockets following national specification

Can be equipped with air distribution, Ethernet distribution following customer request and specifications. We also supply flight case for one or two powerhoods.



SEAMLESS WALLING

IRRESISTIBLE BEAUTY...

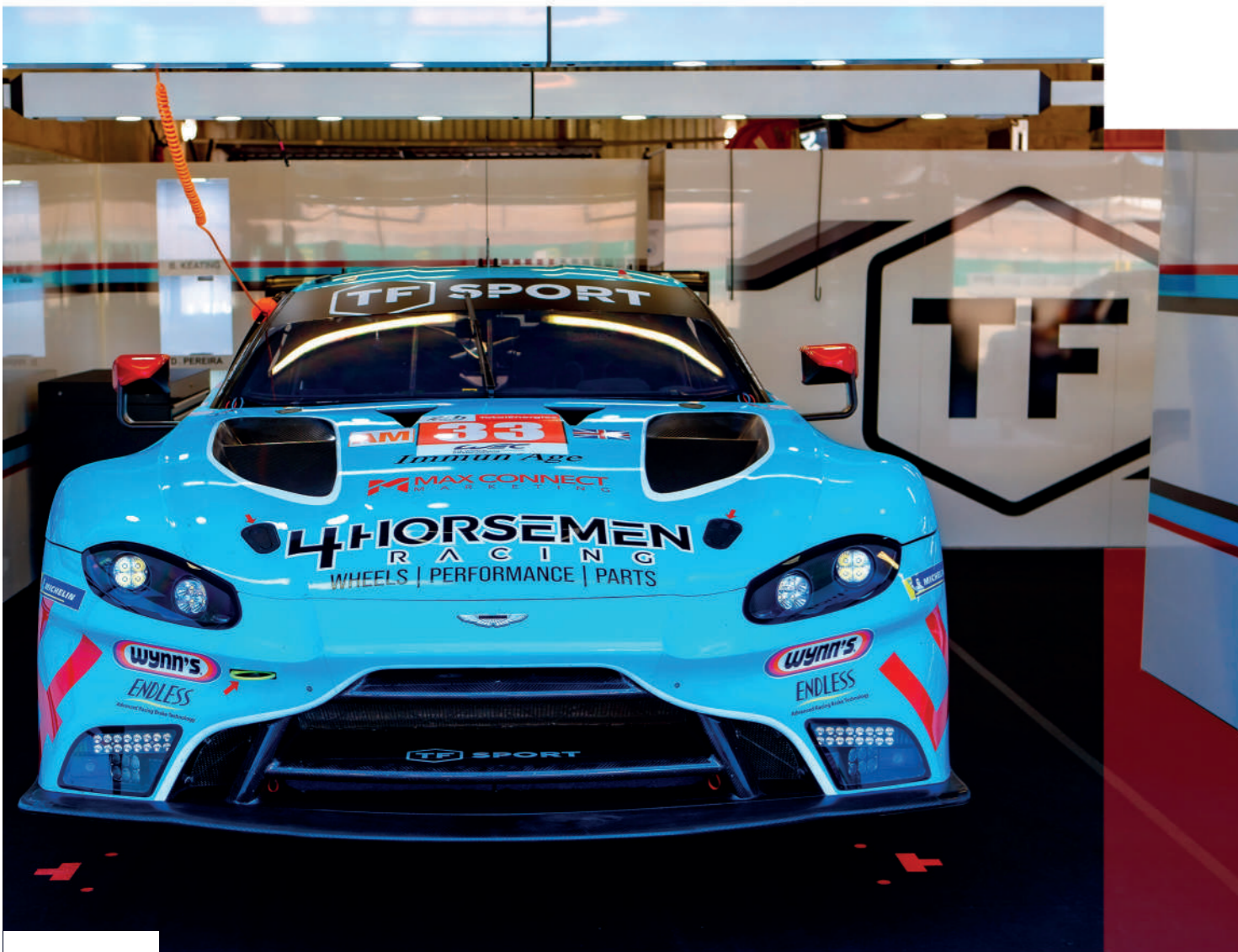

MAGSEAM WALLING

MAGSEAM SEAMLESS WALLING is an aluminum 3mm sandwich-type panel with high rigidity and low weight. The advantages – product quality and perfect seamless surface, the material does not become brittle-hard but shows tough and resilient properties and excellent surface strength. MAGSEAM is both sided and it allows you to finish the look of the walling and to continue the other side.

As an extra you can order LED lighting. The idea is to use the red light to prohibit the entry to pit box and green when the free entry is possible to public or to guests. Or just the LED color matching the team design, allowing to set the color from RGB color chart. We produce our own unique and patented aluminium profiles, build and breakdown time is reduced to minimum.



The visual material may not correspond to the text description, these are illustrative pictures or photos of the products with accessories. Always request an exact specification.

MAGSEAM SEAMLESS WALLING

#0030121001

- basic module max.2030x990mm / 79,92" x 38,97"
- 9,25kg weight / 20,39lb
- round CORNER module for out or in position
- T profile at the crossing of panel walls
- END profile with LED lighting for wall termination-
- 3mm aluminum composite panel
- adjustable feet alignment for the floor
- standard white high glossy color

Options:

- flight case for all parts
- insert the TV monitors
- insert the boxes for drying helmets
- insert the boxes for accessories
- insert work benches
- colors on request
- cut advertising
- print advertising

We can prepare 3D layout of your project, for the best solution.



MAGSEAM WALLING CASE

#01001211CU

Each single garage MAGSEAM project is carefully inserted into the flight case for safe transport. Flight case is equipped with unique system of the panel's protection, including the built-up frame, both avoiding any damage. You can insert inside of the flight case the helmet boxes and TV monitors, corner profiles, T profiles and LED ending profiles.

REFUELING EQUIPMENT

PLACE WHERE TIME IS EVERYTHING...



RF200 REFUELLING RIG

#0150121001

The RF200 tank for quick refueling in endurance races, according to the parameters of the FIA spec. APPENDIX "J", drawing 252-7 or 252-7-2017 regulation. Version RF200-FIA 252-7, code 0150121001 or RF200-FIA-WEC-2017, code 0150121024. Made of aluminum material and with a bottom thickness of 10mm made of milled hardened aluminum. The product price includes a discriminator with flange connection and a Kamlok return hose, a filler cap flange, a ventilation pipe with coupling Kamlok, 2x DASH06 fitting for the installation of the mechanical measurement system. For further specific equipment and technical documentation, please contact our sales department. This description is for informational purposes only.

Optional accessories (not included in price):

0150221003 / HEAT REFLECTIVE COVER

0150211001 / MEASUREMENT FUEL SYSTEM

0150221028 / FIA DEADMAN SC

Equipped from:

CASELINER **KRONTEC** **STÄUBLI**

In the area of fast fueling, we produce a wide portfolio of refueling tanks - rigs. The production includes many accessories for our refueling systems. All products are fully compliant with FIA technical regulations, FIA-WEC, IMSA, and other promoters. We use DIN 4113 certification for welding and choose the highest quality materials. All products undergo functionality and quality testing. Request all technical documentation. All texts can be of informative character and the complete required specification will be created according to the relevant rules.

REFUELLING ACCESSORIES



FIA SINGLE SET PP20M

#custom set

Valve set PP20M, handle, kamlok reducer.



FIA DOUBLE SET PP20M

#custom set

Double valve set PP20M, handles, kamlok reducer.



FIA TANK RECEIVER PP20FTM

#0150221024

Plate refueling valve, receiver.



KAMLOK RFF

#0150231001

Kamlok for RF38 Plutone hose or Stäubli.



STAUBLI SAF45.1838/C

#450001838CX

FIA approved refuelling valve Stäubli SAF 45.



STAUBLI SAF45.5000/DN

#4505000DNJV

FIA approved dry valve for DumpCan.



KRONTEC RFC-88-K-SL

#00RFC88KSL

FIA approved refuelling valve Kronotec RFC.



KRONTEC RFC-88-DN

#00RFC88DN

FIA approved dry valve for DumpCan.



RESTRICTOR FIA / WEG

#0150221004 #015022100X



ADAPTOR RING 3-5

#0150224935

DEAD MAN SC



#0150221028

KAMLOK WEG-ELMS / FIA

#0150221033 #0150221038



NUT RING TYPE A

#0150224999

WEC - LMP1 / ELMS - LMP2



NUT RING TYPE B

#0150224998

WEC / LMGTE



HOSE CLAMP 38R / 57R / 75R

#0150231017 - 19 - 18

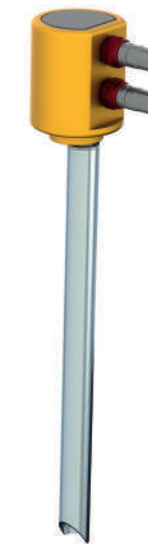

DRUM ADAPTOR SPT12

#0150221175

Drum adapter for safe refueling of the RF200 refueling rig with SPT12 valves and browser.

KRONTEC RFC-20FM

#00RFC20FM

KRONTEC - RFC - FM20 Flow Meter System is another development to race proven refueling system and components. This system allows you to fully see to the total amount fueled to the smallest drop by using sophisticated Ultrasonic flow sensors.



WEIGHING SYSTEM CWU-300

#0150221016

A system for weighing fuel to the car using REFUELLING SCALES CWU300. It is a weighing control mechanism after refueling the car and cannot be used as an active weighing element in the tank refueling process itself at the pit stop. viverra maecenas accumsan lacus vel facilisis.



REFUELING EQUIPMENT

PLACE WHERE TIME IS EVERYTHING...



24



PIT TROLLEY FIA

#0150311001

Basic pit trolley for RF200 system, placing of the air pressure bottles and air pressure regulators. We provide various versions of design - positioning of RF200 and rotary boom longitudinal or transverse position toward to passage in the pit lane. The internal space is arranged for 3 cylinders with a volume of 40-50L.

- flight case construction with strengthening floor steel frame
- 2250x1050x1190mm / 78,74" x 39,37" x 41,33"
- 4 wheels
- holder for 3 cylinders (av. 233mm type)
- standard black color / colors on demand



BOTTLE CAGE BC100

#0150311006

BOTTLE CAGE BC100 is a special holder for the rotary arms and two big cylinders. It is primarily located for GT CHALLENGE SPRINT, DTM, ADAC GT MASTER, and other similar series, where no petrol refueling stop is required at the PIT STOP. Rotary arms on request.

- holder for Guns
- holder for Air Lance
- pressure bottles 40 or 50L



PIT TROLLEY ENDURANCE

#0150311002

PIT TROLLEY ENDURANCE is all new conception with elegant solution in refuelling area, air distribution and complete distribution of tank hoses at PIT STOP area. Trolley has many of storage areas, including practical entry / rear doors to each section. The internal space is arranged for 3 cylinders with a volume of 40-50L.

- aluminum construction
- 2080x1080x1100mm (at. FIA reg.) / 81,88" x 42,51" x 43,30"
- holder for PAOLI RGPRSF 1,2,4 regulators (other on demand)
- standard white color RAL 9010

The visual material may not correspond to the text description, these are illustrative pictures or photos of the products with accessories. Always request an exact specification.

25

REFUELING EQUIPMENT

PLACE WHERE TIME IS EVERYTHING...



ROTARY JOINT IJ100 / IJ100-C

#0150311010

ROTARY JOINT IJ100 is a supporting air hose. Rotating through 360°. Suitable for use at DTM, and all endurance racing series, according to FIA regulation. ROTARY JOINT IJ100-C code 0150311011 is rotation through 360° to complement the ROTARY BOOM IB100 in the DOUBLE BOOM system, according to FIA-WEC regulations.

- stainless steel
- fixing holder or clamp for IB100



DETAIL



DETAIL



ROTARY BOOM INOX IB100

#0150311004

ROTARY BOOM IB100 a supporting air hose. Rotating through 360°. A unique bestseller from our production. Suitable for use at all endurance racing series, according to FIA regulation. You can pass the vent hose through horizontal tube.

- stainless steel
- 4000mm / 157,48"
- 360 ° rotary air piping



DETAIL



ROTARY BOOM CARBON CB200

#0150311020

ROTARY BOOM CARBON CB200. Stylish, lightweight in high-tech design. The peak performance of carbon elements is combined with CNC technology of all aluminum parts. The highest quality of machining, lightweight and very compact size for transport.

- carbon tubes
- telescopic swivel

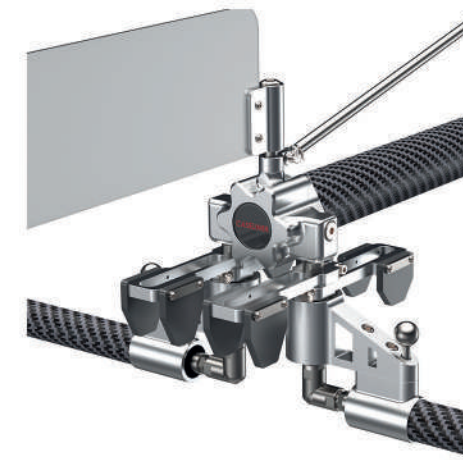

DETAIL



DOUBLE ROTARY BOOM CARBON CB400

#0150311022

ROTARY BOOM CARBON CB400. Another of our range of professional equipment is the ROTARY BOOM CARBON CB400. It has a double rotating arm, which is required especially in WEC, ELMS, Asia LMS competitions. The telescopic arm has the ability to cover complete coverage for your fastest pit stop.

- carbon tubes
- two telescopic swivels

REFUELING EQUIPMENT

PLACE WHERE TIME IS EVERYTHING...



REFUELLING SYSTEM

BR100/200

#BR200BRED A



BR-100 Basic model: 140l capacity and 3 load cells. We have chosen to also equip this model with 3 load cells, with high standard specifications in accuracy, similar to those used for the Top Series version, instead of offering the usual and cheaper single-cell model, because our aim is to offer to our customers a valid equipment over a longtime period. So, do not be fooled by the name, because the Basic model offers excellent and above-average performances and precision.

BR-200 Top Series Evo Carbon model: 200l or 125l capacity and three choices for internal components (Standard, Plus or F1 configurations). In this model, precision has always been the conditio sine qua non for us. No compromise. Only the maximum for this line of refueling equipment that allows a wide range of customizations in capacity, accessories and software to reach the most exigent teams demands.



DUMPCAN DC-6S #150221110
(6L for Stäubli SAF45.5000/DN)

DUMPCAN DC-9S #150221111
(9L for Stäubli SAF45.5000/DN)

DUMPCAN DC-6K #150221112
(6L for Krontec RFC-88DN)

DUMPCAN DC-9K #150221113
(9L for Krontec RFC-88DN)

DUMPCAN DC-9C #150221115
(9L for Krontec RFC-88DN)

REDUCTION D08/SPTI2 #150221150

REFUELLING BOTTLES

CL25

#0150121004



25 L refuelling bottle with 2" valve type PP20M. Enables quick and easy refuelling.



BOTTLE STAND CL25

#0150121006

Refuelling bottle stand for CL25 CASLINER.



REFUELLING BOTTLE

KRONTEC RFC-89-K-FL-45

#RFC-89-K-FL-45

25 L refuelling bottle KRONTEC. With RFC-88 valve and 45°elbow. Enables quick and easy refuelling. We also supply BOTTLE STAND KR25.

REFUELLING TILTED BOTTLES STÄUBLI SAF45

#91025ROJKV



25 L refuelling bottle STÄUBLI - SAF45.1025/RO. Enables quick and easy refuelling.



BOTTLE STAND ST25

#0150121007

Refuelling bottle stand for ST25 Stäubli Bottle Tilted.



REFUELLING BOTTLE

KRONTEC RFC-89-K-FL

#RFC-89-K-FL

25 L refuelling bottle KRONTEC. With RFC-88 valve. Enables quick and easy refuelling. We also supply BOTTLE STAND KR25.

PIT PERCHES

MISSION CONTROL...



LED TIMING BOARD CL4

#0080121001



LED TIMING BOARD CL8

#0080121006

Electronic LED information panel, which is intended to show information's to the drivers, which are passing through the pit area. High intensity led lights, excellent visibility during high-speed drive through, many effects, warning functions, text and image displaying. Simple software with the large number of language versions. Most widely used for endurance races as 24 Le Mans, WEC, VLN Series, 24SPA and many other race series.

- LED diodes – amber color / highlight, visible in direct sunlight (pn.0080121001)
- LED diodes – 7 color + inv. color / highlight, visible in direct sunlight (pn.0080121006)
- front antireflection Plexiglas
- very lightweight aluminum construction with protection IP67
- dimensions 1000x700x80mm / 39,37" x 27,55" x 3,14"
- weight 17kg / 37,47 lb
- FIA/WEC/IMSA regulation specification
- communication via ETHERNET RJ45 cable or BLUETOOTH II (100m)
- automatic voltage regulator sensitive input 100V or 230V



ELECTRONIC SLIDING BOARD

#0080121007

Universal sliding system can be used manually or with motorized option. Engine drive option is controlled with software CL4/8SW via Bluetooth or cable RJ45 ETHERNET solution. We also supply optional flight case which can be used as a holder for the system.



PIT PERCH FORMULA

#0070131001

Stainless steel construction, textile roof and side walls with zipper system. It is extremely fast to set up into 10 minutes. One shelf inside provides support for laptops and monitors. The roof and side parts are fully partible and can be used up to three variants of using the side parts. PIT PERCH can be supplied as a basic module with a special bag or with platform and transport box FLIGHT CASE type, which includes required number of rotating CHAIRS with high back.

- width 2100mm / 82,67"
- depth roof 1200mm / 47,24"
- high 2200 mm / 86,61"
- weather protection / AATCC - 22 Spray test
- top quality zipper system
- basic color black

TV/LCD MONITOR CASE

#0070111003

Transport and installation flight case for LCD/TV, which is designed for installation into the PIT PERCH, garage or VIP are for monitoring of results, camera systems and TV broadcasts.

- 9 mm plywood / 0,35" black plywood
- TV and electric main / splitter

LED/ DBV-T and hanging system are not included in price.



PIT PERCH ENDURANCE

#0070131011

PIT PERCH ENDURANCE is designed for 3 engineers. Its design is very elegant, it will attract the attention to your team at the circuit. The basic structure is made of stainless steel tubes with easy connection system. The roof and side parts you can use as the single items and use it as according to the actual climate conditions. Pit perch can be completely closed and protect you from the rain. Very fast installation due to zip-fasteners which are waterproof.

- width 2300mm / 90,55"
- depth roof 1200mm / 47,24"
- high 2200 mm / 86,61"
- weather protection / AATCC - 22 Spray test
- top quality zipper system
- basic color black

AIR EQUIPMENT

WE SPEED YOUR NEED...

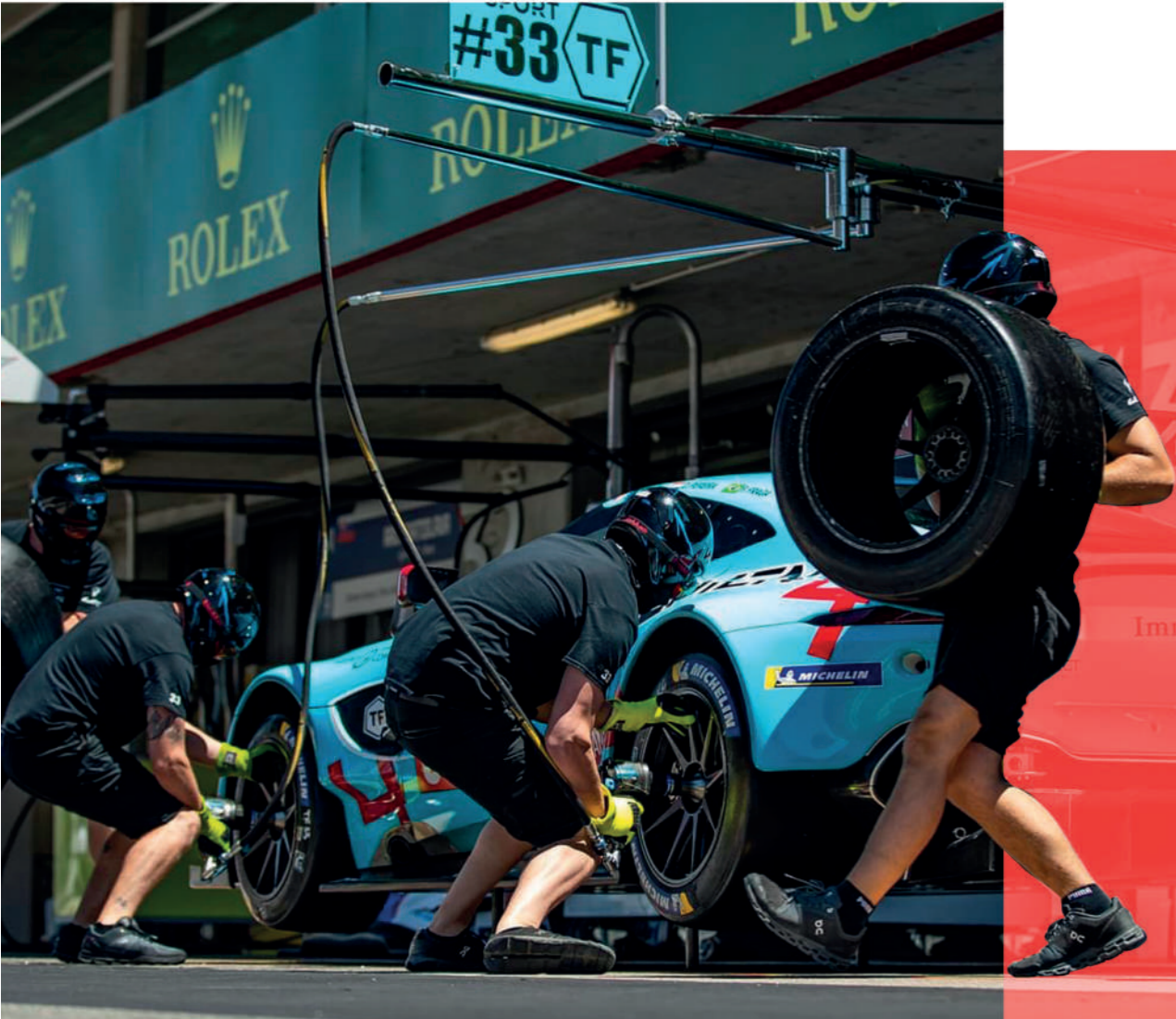

AIR JACK STANDARD

#0051041003

Standard air jack for formula and single seater cars. In order to adapt your special attachments for your vehicle.

- load capacity 500kg /1102,31 lb
- working pressure 6-10 bar / 87-145 psi



ENGINE - GEARBOX LEVER TROLLEY

#0051041050

Standard or Big versions or model with customized top, specifically projected for the requester customer.



WHEEL HUB HOLDER

#0170121001

Special holders for use - deploying to the central hub of the racing cars. Models for ORECA O5, LIGIER JS P3, GINETTA H57, GT3 cars and other on request.

DINO PAOLI

We offer complete air-equipment DINO PAOLI for Your team. Dino Paoli S.r.l. was established in 1968 as specialized makers of pneumatic impact wrenches and accessories.



	HURRICANE Classic handle	DP6000 Classic handle	DP5000 TI MARK II	DP4000 MG	DP3000 SUPERSPORT	DP2000 SE
LH Version:	HURRICANE.022	006000.00017	5000TI.00022	4000MG.00037	3000SS.00001	2000SE.00010
RH Version:	HURRICANE.023	006000.00018	5000TI.00023	4000MG.00038	3000SS.00002	2000SE.00011
UH Version:	HURRICANE.024	006000.00019	5000TI.00024	4000MG.00039	3000SS.00003	2000SE.00012
Square drive:	1"	1"	1"	1"	1"	1"
Weight:	3,7 kg / 8,15 lbs	3,5 kg / 7,7 lbs	3,43 kg / 7,5 lbs	3,71 kg / 8,18 lbs	4kg / 8,82 pbs	3,90kg / 8,6 lbs
Free Speed:	14800 rpm	14700 rpm	14500 rpm	13500 rpm	11500 rpm	9500 rpm
Max Pressure:	25 BAR	25 BAR	25 BAR	20 BAR	20 BAR	20 BAR
Max Torque:	4300 Nm	4200 Nm	3800 Nm	3500 Nm	3000 Nm	2500 Nm

LH and RH Version. Other guns DP197, DP177, DP176, BLUE DEVIL, DP36, TOPREDO please see to PAOLI website.



WHEEL NUTS & SOCKETS

The new Paoli sockets are an unprecedented product and the result of a long and complex engineering research. Consultation with hundreds of race clients has ensured that the Paoli Sockets' technological development goes hand in hand with the real needs of racing teams in terms of versatility, safety, materials and maintenance. We send you complete offer for your option.

Two different materials: titanium and aeronautical aluminium, the first suitable for the race application and the second suitable for non-intensive use and torque wrench.

Innovative safety system for inserting the pin into the through the socket/square drive. Revolutionary system when assembling the socket by using the spring clip and an 'O' ring on the cover. Maximum safety, a fine fitting and a considerably reduced assembly time.

The visual material may not correspond to the text description, these are illustrative pictures or photos of the products with accessories. Always request an exact specification.

AIR EQUIPMENT

WE SPEED YOUR NEED...



PAOLI REGULATORS

Main features: Paoli regulators have all been conceived to first guarantee the correct (very high) air flow to all the models of Paoli guns. Furthermore, all the Paoli regulators minimize the pressure drop from static to dynamic. We do deliver mostly piston regulators for high pressure and diaphragm regulators for lower pressures. We do always recommend to match a high flow oiler to each regulator and to ship them back to us for service.



F1 REGULATOR

#B.40.0001

220BAR inlet, 0-100 BAR out, 150Mn3/h, 30BAR over pressure valve setting, medium flow.



F2 REGULATOR

#B.40.0002

220BAR inlet, 0-100 BAR out, 150Mn3/h, 50BAR over pressure valve setting, medium flow



F4 REGULATOR

#B.40.0005

220BAR inlet, 0-100 BAR out, 400Mn3/h, 50BAR over pressure valve setting, high flow

We also offer 350 BAR version. Please contact us.



TURNING CONNECTORS

#B.43.0001

DV11MFG38 and other variants

HOSES 75 BAR

#B.41.1001

Technical data - bore size: 13 mm, braid od: 23,5 mm, working pressure: 75 bar. Final ending - fitting on demand 3/8" or 1/2".



MK/DP FLIGHT CASE COMPRESSOR

#0050911001

Special flight case for compressor, 1000x450x600, 4 wheels



AIR BOTTLES COMPRESSOR DPH220

#B.21.0102

Single-phase Electric, 2,2kW, 3HP, 300BAR, 100L/min.



AIR BOTTLES COMPRESSOR DPH460

#B.21.0102

Subaru Robin Petrol Engine, 4,6, 3HP, 300BAR, 100L/min.

COUPLING

QUICK AND SPEED CONNECTION...



COUPLING CEJN



	CEJN	CEJN	CEJN	CEJN	CEJN	CEJN	CEJN	CEJN	CEJN
Code:	0104101155	0104101154	0103201155	0103201154	0103202154	0104105155	0104105154	0103205155	0103205154
Type:	coupling	coupling	coupling	coupling	saf/coupling	plug	plug	plug	plug
Standart:	410 EU-10,4mm	410 EU-10,4mm	320 EU-7,6mm	320 EU-7,6mm	320 EU-7,6mm	410 EU-10,4mm	410 EU-10,4mm	320 EU-7,6mm	320 EU-7,6mm
Thread:	R1/2"	R3/8"	R1/2"	R3/8"	R3/8"	R1/2"	R3/8"	R1/2"	R3/8"
Type of thread:	male	male	male	male	male	male	male	male	male
Length:	53mm	53mm	40mm	47mm	47mm	40mm	40mm	31mm	28mm
Pressure:	16 BAR	16 BAR	16 BAR	16 BAR	16 BAR	16 BAR	16 BAR	16 BAR	16 BAR

Serie 320 - working pressure 16 bar, min. burst pressure 140 bar, flow capacity 2100l / min • Serie 410 - working pressure 16 bar, min. burst pressure 140 bar, flow capacity 3900l / min

COUPLING OETIKER / TSC



	OETIKER	OETIKER	OETIKER	OETIKER	OETIKER	OETIKER	OETIKER	OETIKER	OETIKER
Code:	0020500107	0020500106	0020500353	0020500352	0020500351	0025500075	0025500074	0025500025	0025500024
Type:	coupling	coupling	coupling	coupling	coupling	plug	plug	plug	plug
Standart:	SC H / DN11	SC H / DN11	SC C / DN8	SC C / DN8	SC C / DN8	SC H / DN11	SC H / DN11	SC C / DN8	SC C / DN8
Thread:	G1/2"	G3/8"	G1/2"	G3/8"	G1/4"	G1/2"	G3/8"	G1/2"	G3/8"
Type of thread:	male	male	male	male	male	male	male	male	male
Length:	70,3mm	70,3mm	58,5mm	57,5mm	57,5mm	45mm	45mm	31mm	31mm
Pressure:	25 BAR	25 BAR	25 BAR	25 BAR	25 BAR	25 BAR	25 BAR	25 BAR	25 BAR

Serie DN8 - working pressure 25 bar, disconnection pressure 15 bar • Serie DN11 - working pressure 25 bar, disconnection pressure 15 bar

MECHANIC & VIP AREA

WHEN YOU HAVE TIME FOR BREAK AND COFFEE...

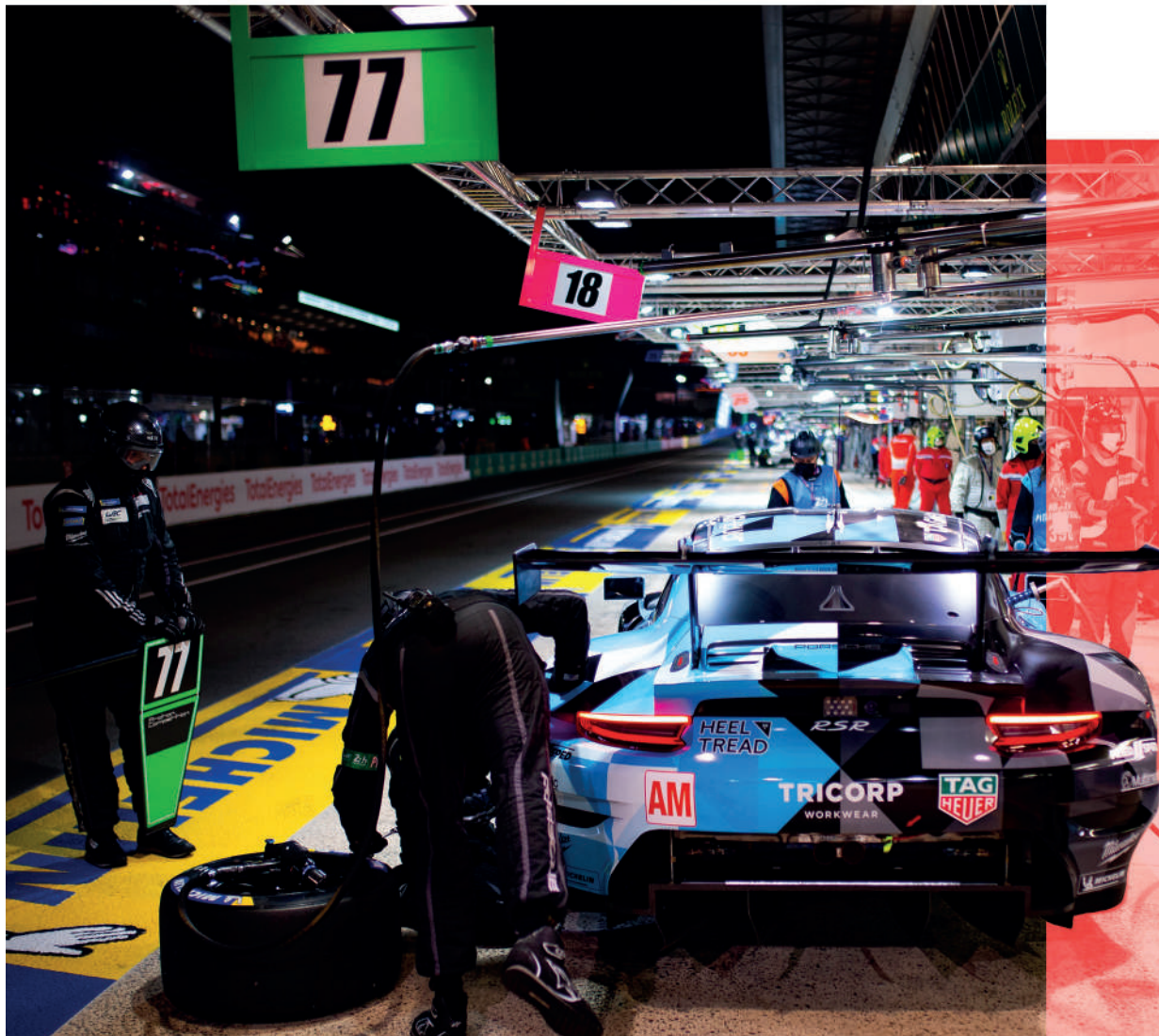

BELT BARRIER

#0032001CHR

Mechanism equipped with centrifugal belt-breaking system. Belt length is 2,3 m and it's available in colors black, grey, blue or red. Bags, printing and transport flight cases are optional

- height 1000 mm / 39,37"
- belt length 2,3 m / 90,55"
- total weight approx. 12 kg / 26,45 lb



PIPE BARRIER

#0130231001

Made from stainless steel and are dedicated for exclusive area mark off for the teams, backstage or VIP area. Advantage is flat full surface with possibility to use it for advertising or other graphic design elements.

- height 1100 mm / 3,60 ft
- length 1600 mm / 5,24 ft



BELT BARRIER FLIGHT CASE BBFC

#0130111001

Special protective and transport flight case for 12 PCs BELT BARRIERS CLASSIC.

FLIGHT CASE TCH

#160131020

Flight case for 4 tables + 20 chairs



VIP FOLDING TABLE

#0160131003

Flight case for 4 tables + 20 chairs

BAR FOLDING TABLE

#0160131004

Folding bar high table, steel frame, quality composite PVC table desk.

VIP FOLDING CHAIR

#0160131002

Folding chair, steel frame, seat quality PVC table desk.



CATERING BASIC

#0010311001

Mobile CATERING CASE BASIC is including shelves, sink with outlet water drain, plate, ice box. Optimal for smaller teams.

- 1200 x 700 x 1100 mm / 47,24" x 27,55" x 43,30"
- 3x drawers w. permanent files
- ice box - fridge 40L / 10,56 gal
- electric double hot-plate
- sink + water heater + waste



BAVERAGE CATERING

#0010311005

Beverage box with a refrigerator for cooling of the drinks. The right side is space for supplies, glasses and other material.

- 1500 x 600 x 1080 mm
- double sliding doors fridge





TEAM
HERBERTH
motorsport

RICHARD MILLE

1

ALPINE



CASELINER® | PIT STOP PREMIUM

CASELINER[®]

MOTORSPORT PIT EQUIPMENT

CASELINER S.R.O.

Nad Jezerem 568
252 50 Vestec
Czech Republic

Cell: [+420 724 728 478](tel:+420724728478)
Phone: [+420 244 463 151](tel:+420244463151)
E-mail: info@caseliner.com
Web: www.caseliner.com



WWW.CASELINER.COM